

**UNISER**  
INDUSTRIES PVT. LTD.

**PROFILE LIGHTS**  
SERIES

PRODUCT OVERVIEW TECHNICAL DOCUMENT  
EDITION APRIL 2020



**MODEL NO. :  
UHLS-8A SURFACE**

**PROFILE SERIES**



**DIMENSIONS**

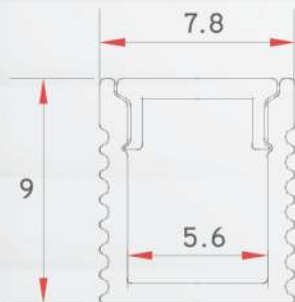

**ACCESSORIES**





MODEL NO. :  
UHLS-8B CONCEALED

PROFILE SERIES

### DIMENSIONS

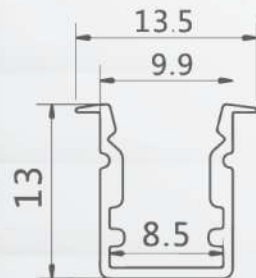

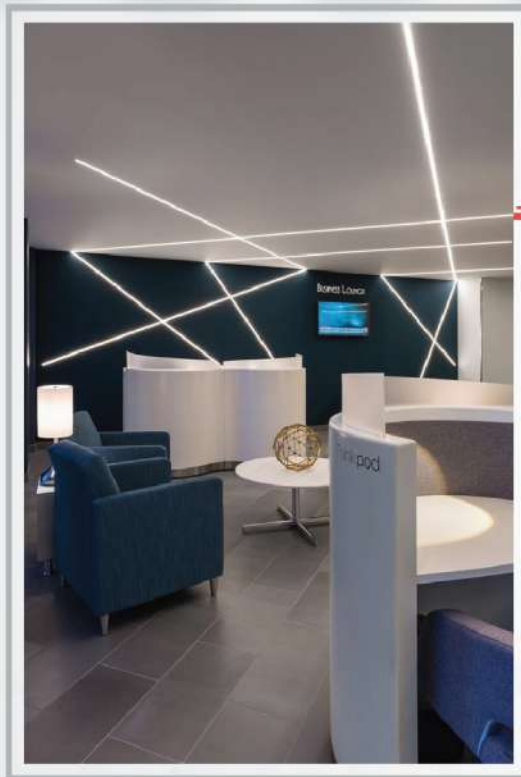

**MODEL NO. :  
UHLS- 17A SURFACE**

**PROFILE SERIES**



**DIMENSIONS**

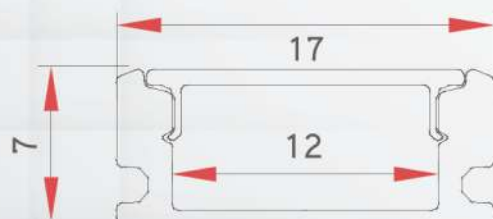

**ACCESSORIES**





MODEL NO. :  
UHLS-17A DEEP SURFACE

PROFILE SERIES



DIMENSIONS

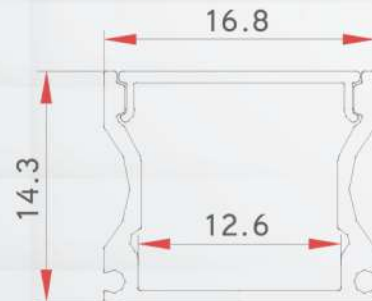

ACCESSORIES

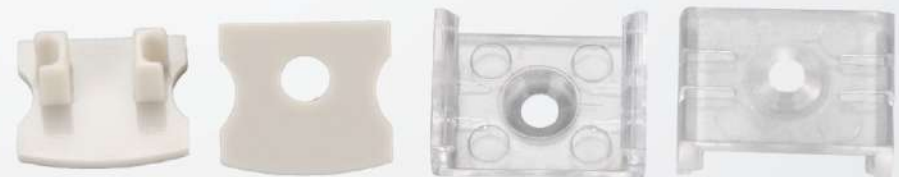



**MODEL NO. :  
UHLS-17B CONCEALED**

**PROFILE SERIES**



**DIMENSIONS**

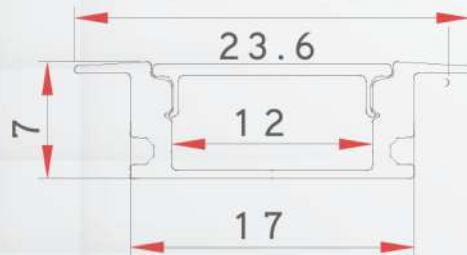

**ACCESSORIES**





MODEL NO. :  
UHLS-17B DEEP CONCEALED

PROFILE SERIES



**DIMENSIONS**

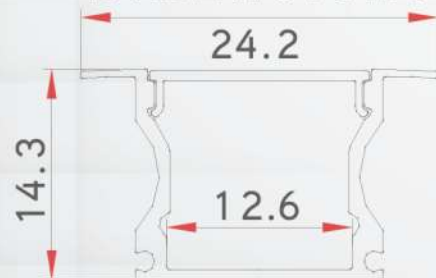

**ACCESSORIES**





MODEL NO. :  
UHLS-17C SURFACE

PROFILE SERIES

TRANSPARENT DIFFUSER



ACCESSORIES



DIMENSIONS

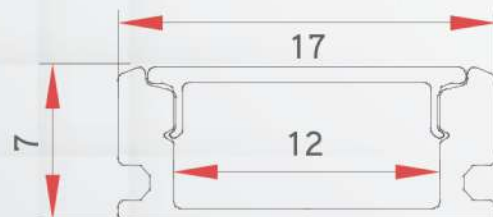





MODEL NO. : UHLS-17D  
**TRANSPARENT DIFFUSER**

**PROFILE SERIES**



**ACCESSORIES**



**DIMENSIONS**

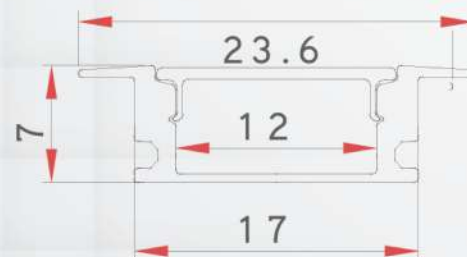



MODEL NO. :  
UHLS-18A CORNER PROFILE

PROFILE SERIES



DIMENSIONS

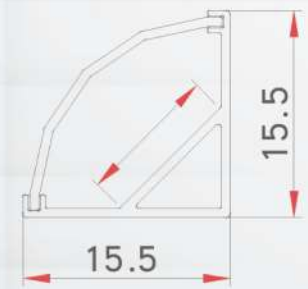

ACCESSORIES





**MODEL NO. :  
UHLS-25A SURFACE**

**PROFILE SERIES**



**DIMENSIONS**



**ACCESSORIES**



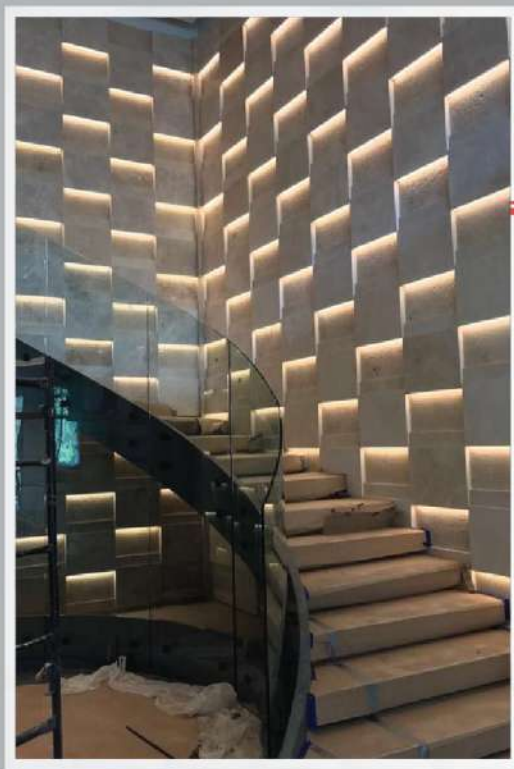

**MODEL NO. :  
UHLS-25B CONCEALED**

**PROFILE SERIES**



**DIMENSIONS**



**ACCESSORIES**





**MODEL NO. :  
UHLS-3535B CONCEALED**

**PROFILE SERIES**



**DIMENSIONS**

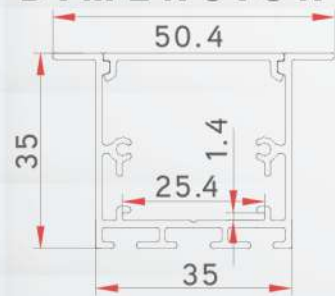

**ACCESSORIES**

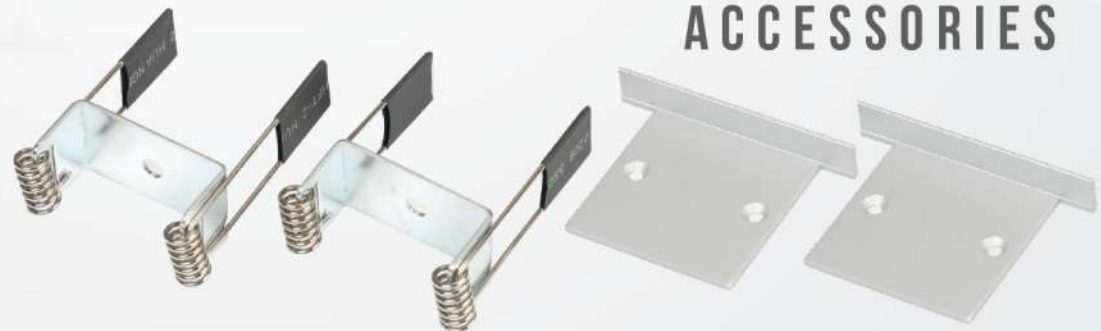

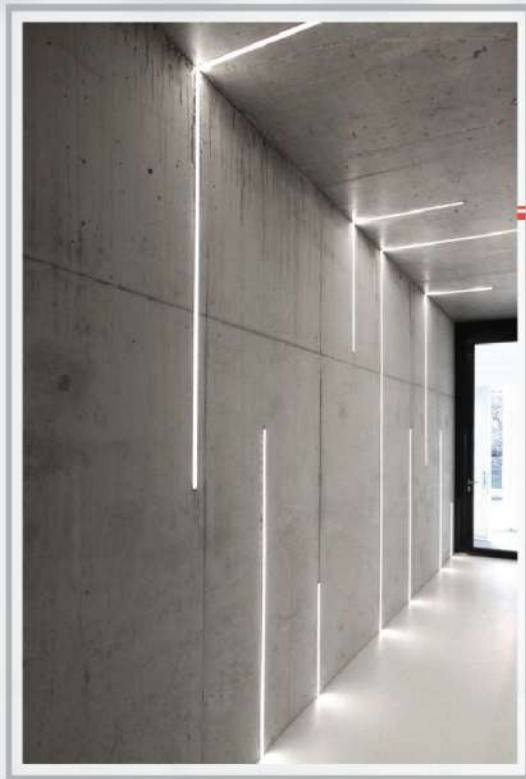

**MODEL NO. :  
UHLS-3535A SURFACE**

**PROFILE SERIES**



**DIMENSIONS**

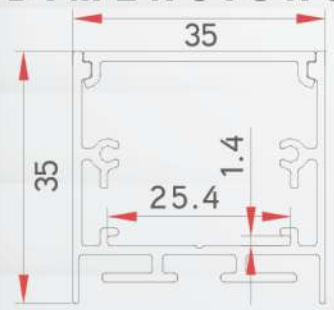

**ACCESSORIES**



**MODEL NO. :  
UHLS-5575 A SURFACE**

**PROFILE SERIES**



**DIMENSIONS**

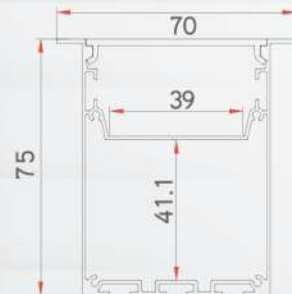

**ACCESSORIES**



# UNISER

## INDUSTRIES PVT. LTD.

To place your order, please contact

HELPDESK DETAILS :

414, Lotus House, 33-A, V Thackersey Marg, New Marine Lines, Mumbai 400020, India

Tel: 022 22000515

Mob: +91 9867625686

Email : [projects@uniserledlights.com](mailto:projects@uniserledlights.com) | [support@uniserledlights.com](mailto:support@uniserledlights.com)  
[www.uniserledlights.com](http://www.uniserledlights.com) | [www.unisersolar.com](http://www.unisersolar.com)